

*PORTABLE
KEROSENE-HEATER*
“OWNER'S MANUAL”

DuraHeat[®]

**MODEL:
DH 2302**



Before the first use of this heater, please read this OWNER'S MANUAL very carefully. This OWNER'S MANUAL has been designed to instruct you as to the proper manner in which to assemble the heater, maintain the heater, store the heater, and most importantly, how to operate the heater in a safe and efficient manner, please keep this manual for future reference.

**WORLD MARKETING OF AMERICA, INC.
RT. 22 WEST, P.O. BOX 192
MILL CREEK, PA 17060
1-800-776-9425 (9 AM - 4 PM EST)
MON.-FRI. ONLY
www.yourheater.com**

**NEVER LEAVE THE HEATER
UNATTENDED WHILE BURNING!**

CAUTIONS - SAFETY GUIDE -

1 WARNING!! RISK OF EXPLOSION / RISK OF FIRE

- ! **NEVER** use any fuel other than water-clear 1-K kerosene.
- ! **NEVER** use fuel such as gasoline, benzene, paint thinners or other oil compounds in this heater.
- ! **NEVER** refill heater fuel tank when heater is operating or still hot.
- ! **NEVER** use heater in areas where flammable vapors or gases may be present.
- ! **NEVER** fill heater fuel tank in living space; fill tank outdoors.
- ! **NEVER** store or transport kerosene in other than a metal or plastic container that is (1) acceptable for kerosene, (2) non-red in color, and (3) clearly marked "Kerosene." **NEVER** store kerosene in the living space; kerosene should be stored in a well ventilated place outside the living area.

! The unit is **EXTREMELY HOT** while in operation. Due to high surface temperatures, keep children, clothing, furniture, and other combustible objects at least 36" away from top and front area.

! **NEVER** use gasoline in this heater. (RISK OF FIRE)

! RISK OF INDOOR AIR POLLUTION

USE HEATER ONLY IN WELL VENTILATED AREAS. People with breathing problems should consult a physician before using the heater. In a house of typical construction, that is, one that is not of unusually tight construction due to heavy insulation and tight seals against air infiltration, an adequate supply of air for combustion and ventilation is provided through infiltration; however, if the heater is used in a small room where less than 200 cubic feet (5.7 m³) of air space is provided for each 1,000 BTU per hour of heater rating (considering the maximum burner adjustment), the door(s) to adjacent room(s) should be kept open or the window to the outside should be opened at least 1 inch (25.4 mm) to guard against potential buildup of indoor air pollution. **DO NOT** use the heater in a bathroom or any other small room with the door closed.

! **NEVER** use heater to heat or boil water or use as a cooking appliance.

2 WARNING!! FAILURE TO INSTALL, MAINTAIN, AND/OR

OPERATE THIS KEROSENE HEATER ACCORDING TO MANUFACTURER'S INSTRUCTIONS MAY RESULT IN CONDITIONS WHICH CAN PRODUCE BODILY INJURY AND/OR PROPERTY DAMAGE.

NOTE: The **WARNING** and **IMPORTANT** instructions appearing in this manual are not meant to cover all possible conditions and situations that may occur. It must be understood that common sense, caution, and carelessness are factors which cannot be built into this heater. These factors must be supplied by the person(s) installing, maintaining, or operating the kerosene heater.

Always contact your dealer, distributor, service agent, or the manufacturer on any problems or conditions you do not understand.

! **NEVER** leave heater operating if you intend to leave for any period of time. Always make sure to turn heater off and inspect to insure that it is completely extinguished prior to going to bed.

! **NEVER** leave heater unattended.

! **NEVER** use as a source of heat for drying objects.

! **NEVER** place objects on the top plate.

3 WARNING!! RISK OF BURNS

! **NEVER** operate the heater without the guard or grille completely attached.

4 IF POOR QUALITY KEROSENE is used a rapid accumulation of carbon and tar is likely. This may cause a strong odor and will destroy the wick. Additional heater damage may occur as the wick becomes more difficult to adjust. The use of poor quality fuel could also make the wick very hard to extinguish. Always make sure the fire is out. (See page 12, Extinguishing the Heater.)

5 ADJUSTMENT OF ROOM TEMPERATURE can not be changed by adjusting the heater. A kerosene heater is either on or off. There is no temperature adjustment. If heater output is reduced by lowering the wick in any way, improper combustion will occur producing odors and an accumulation of tar and carbon. If your room becomes too hot, open a door or a window or turn off the heater.

SAVE THESE INSTRUCTIONS FOR FUTURE REFERENCE!!

**NEVER LEAVE THE HEATER
UNATTENDED WHILE BURNING!**

CONTENTS OF OWNER'S MANUAL

<u>ITEM</u>	<u>PAGE</u>	<u>ITEM</u>	<u>PAGE</u>
CAUTIONS-SAFETY GUIDE	1	10 CARBON REMOVAL / DRY BURNING	8
1 INTRODUCTION	2	11 WICK ASSEMBLY	9
2 FEATURES	2	12 WICK REPLACEMENT	9-11
3 UNPACKING AND ASSEMBLY	3-4	13 EXTINGUISHING THE HEATER	12
4 KEROSENE (1-K ONLY)	4-5	14 AUTOMATIC OVER HEAT SHUT-OFF SYSTEM	12
5 FUELING YOUR HEATER	5	15 AUTOMATIC SAFETY SHUT-OFF DEVICE	12-13
6 AUTOMATIC IGNITION SYSTEM	6	16 LONG TERM STORAGE OF YOUR HEATER	13
7 CHECKING THE IGNITION SYSTEM	7	17 SPECIAL SAFETY PRECAUTIONS	14
8 ADJUSTING THE WICK	7-8	18 PARTS LIST	15
9 WICK MAINTENANCE	8	19 EXPLODED PARTS DRAWING	15
		20 SPECIFICATIONS	15

1 INTRODUCTION

Please read this OWNER'S MANUAL carefully. It will show you how to assemble, maintain, and operate the heater safely and efficiently to obtain full benefit from its many built-in features.

2 FEATURES

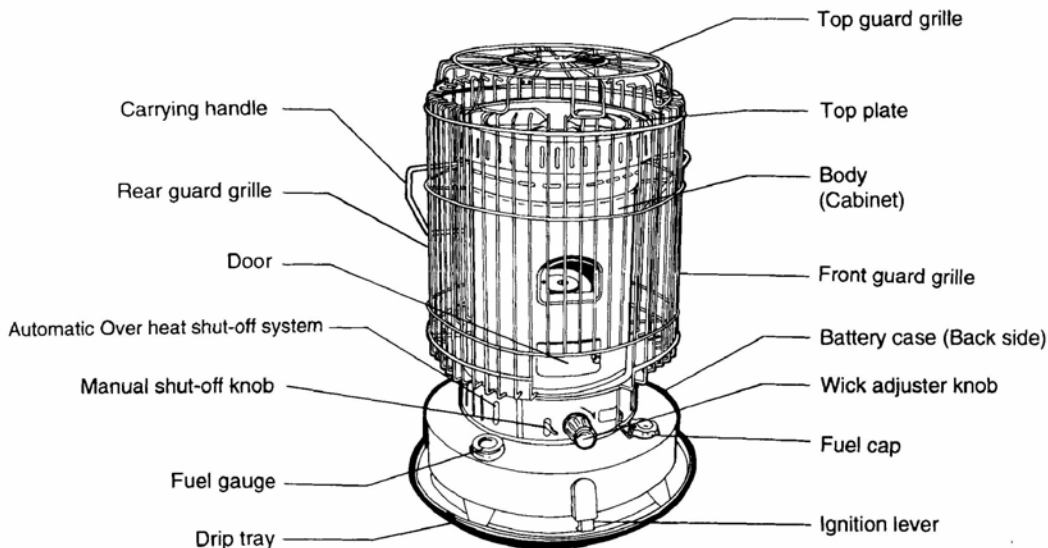

Fig. 1

**NEVER LEAVE THE HEATER
UNATTENDED WHILE BURNING!**

UNPACKING AND ASSEMBLY

CAUTION : "RISK OF BURNS"

DO NOT OPERATE HEATER WITHOUT INSTALLING THE PROTECTIVE GUARD OR GRILLE.

1. REMOVE THE HEATER AND ALL PACKING MATERIALS FROM THE BOX.(Fig. 2)

NOTE: Save the shipping carton and packing materials for future storage.

- Heater.
- Drip tray.
- Top guard.
- Handle.
- Top plate
- 2 "C" cell batteries.
- Siphon pump.
- Bag of screws for top grille assembly.
- Owner's manual.
- Safety Tips Manual.

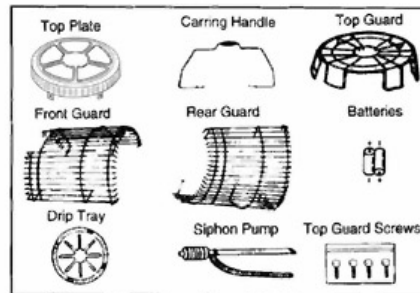

Fig. 2

2. ASSEMBLING.

A) REMOVING GUARDS : (Fig. 3)

Remove the front and rear guards (which have been lowered for packing) from the heater by pushing downward on the grill rods where they enter the heater and pull outward.

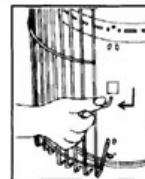

Fig. 3

B) Remove all packing materials from heater. (Fig. 4)



Fig. 4

C) MOUNTING TOP PLATE : (Fig. 5)

Place the top plate on the cabinet. Make certain the two(2) holes on inner top plate align with carrying handle hole on the cabinet.

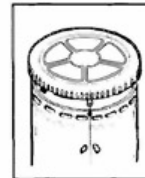

Fig. 5

D) REINSTALLING FRONT AND REAR GUARDS:(Fig. 6)

- Insert the upper portion of the grill rods of the front guard into the highest holes by pushing upward as you insert the grill rods into the cabinet.
- Insert the lower portion of the grill rods of the front guard into the lower holes by inserting the grill rods into the heater and pushing downward.
- Install the rear guard in the same way.

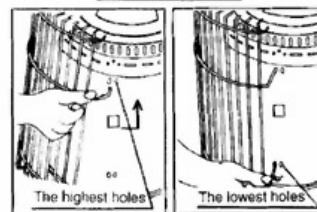

Fig. 6

NEVER LEAVE THE HEATER UNATTENDED WHILE BURNING!

E) INSTALLING CARRYING HANDLE:(Fig. 7)

Insert the carrying handle into the holes on the cabinet by aligning holes on brackets of top plate.

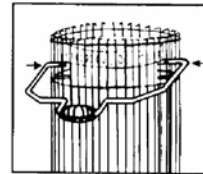

Fig. 7

F) INSTALLING TOP GUARD:

- Align the 4 brackets on the top guard with the 4 mounting brackets on the front and rear guards.
- Secure each bracket with a screw. Make sure that the brackets on the top guard are positioned inside the mounting brackets on the front and rear guards. (Fig. 8)

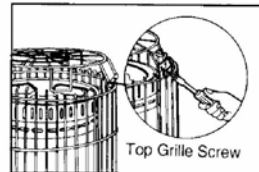

Fig. 8

G) INSTALLING DRIP TRAY. (Fig. 9)

- Place the heater on the drip tray with four legs(4) of the heater located next to four tabs(4) on the drip tray.
- Turn the heater clockwise until the feet slide into their tabs and stop.

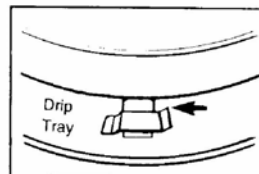

Fig. 9

H) INSTALLING BATTERIES. (Fig. 10)

- Battery holder is located on the back of the heater.
- Open the battery cover from the battery case.
- Insert two(2) "C" cell batteries according to the plus(+) and minus(-) markings inside of the holder.
- Replace the battery cover to the heater.

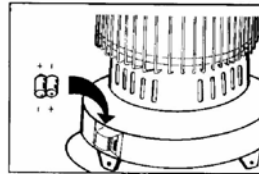

Fig. 10

I) Now your heater is completely assembled.(Fig. 11)

4 KEROSENE (1- K Only)

It is **EXTREMELY IMPORTANT** to the operation of this heater that you use the proper grade of kerosene. The proper grade of kerosene is identified as **1-K Kerosene**. **DO NOT OPERATE THIS HEATER WITH ANY FUEL OTHER THAN 1-K KEROSENE!** 1-K Kerosene has been refined to virtually eliminate contaminants such as sulphur, which can cause a rotten egg odor during operation of the heater.

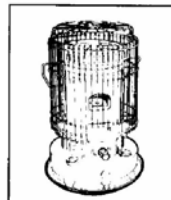

Fig. 11

KEROSENE SHOULD ONLY BE STORED IN A BLUE CONTAINER THAT IS CLEARLY MARKED "KEROSENE". NEVER STORE KEROSENE IN A RED CONTAINER. Red containers are associated with gasoline.

NEVER store kerosene in the living space. Kerosene should be stored in a well ventilated place outside the living area.

NEVER use any fuel other than water-clear 1-K kerosene.

NEVER use fuel such as gasoline, benzene, alcohol, white gas, camp stove fuel, paint thinners, or other oil compounds in this heater. These are volatile fuels that can cause explosion or uncontrolled flames.

The best way to purchase kerosene is in a pre-packaged, metal or plastic, blue colored container.

The second choice would be to buy it from a dealer who stores it in a 55 gallon drum. The third choice is to buy kerosene from a dealer who stores it in a large underground (or above ground) tank. Kerosene that is contaminated with even a small amount of water will prevent a kerosene heater from functioning properly. As you move from the first choice in purchasing kerosene (pre-packaged container) to the third choice (large storage tank), the likelihood of water being present from condensation increases.

If you purchase kerosene in bulk, know your dealer.

**NEVER LEAVE THE HEATER
UNATTENDED WHILE BURNING!**

It is normal for a kerosene heater to give off a slight odor upon start-up and shut-down. After 5-10 minutes of operation, the heater should have reached its normal operating temperature and any odor should be very slight.

NEVER store kerosene in direct sunlight or near a source of heat.
NEVER use kerosene that has been stored from one season to the next.
Kerosene deteriorates over time. **"OLD KEROSENE" WILL NOT BURN PROPERLY IN THIS HEATER.**

A variety of problems can result from using poor quality kerosene ... smoke, odor, low flame, difficult ignition, difficult shut-down, flame flickers and dies, excessive burning down of the wick, reduced wick life, wick adjuster sticking, excessive deposits on the wick, etc.. If you encounter any of the problems listed above, check your kerosene. If you discover that the kerosene is the problem, get a fresh supply of **WATER-CLEAR 1-K KEROSENE** before using your heater again.

FUELING YOUR HEATER

**NEVER FILL THE HEATER FUEL TANK IN THE LIVING SPACE :
FILL THE TANK OUTDOORS.**

Before fueling the heater, take the heater, the kerosene, and the manual siphon pump outdoors. To use the manual siphon pump, tighten the cap on the top of the siphon, place the straight tube into the kerosene container, and insert the flexible tube into the opening of the fuel tank. By squeezing the bulb of the siphon pump, fuel will be transferred from the kerosene container into the heater tank(Fig.12). Carefully watch the fuel gauge on the base of the heater so that you will know when the tank is getting full. When you approach the full mark, loosen the cap on top of the siphon pump. **DO NOT OVERFILL YOUR HEATER.** Allow the siphon pump to drain thoroughly before you remove it from the tank and the kerosene container.

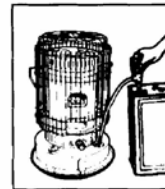

Fig. 12

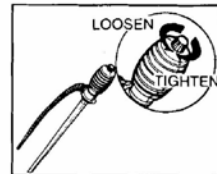

Fig. 13

After fueling the fuel tank of the heater by using siphon pump, make sure that you loosen (counter clock wise) the cap on the siphon pump to drain thoroughly the remaining kerosene in the siphon pump. For the reuse of siphon pump, make sure that you tighten (clock wise) the cap on the siphon pump to transfer the kerosene into the fuel tank properly.(Fig. 13)

IMPORTANT NOTICE REGARDING FIRST FUELING OF HEATER : When first using your heater, make sure that you allow **a minimum of 30 minutes** (carefully check the time) **after filling the tank before you attempt to light the heater.** This allows time for the wick to become saturated.

IMPORTANT NOTICE REGARDING FIRST IGNITION OF HEATER : The first time you light the heater, it should be done **outdoors.** This allows the oils, etc. used in manufacturing the heater to burn off outside, rather than inside your home.

IMPORTANT NOTICE ; NEVER refill heater fuel tank when heater is operating or still hot.

NEVER LEAVE THE HEATER UNATTENDED WHILE BURNING!

6 AUTOMATIC IGNITION SYSTEM

For safety and convenience, this heater features an automatic ignition system. **2 "C"** cell batteries, included with the heater, provide the power for the igniter which lights the wick once it has been raised to its maximum height.

To use the automatic ignition system :

- Make sure the batteries have been installed.
- Turn the wick adjuster knob clockwise until the wick has been raised to its maximum height.(Fig.14)
- Pull on the ignition lever(Fig. 15) to bring the glowing igniter into contact with the wick. This will cause ignition to occur.
- As soon as you see that the wick has been lit, release the ignition lever. This will automatically lower the burn chamber back down over the wick.
- Rotate the burner knob from side to side a few times to make sure that the burner is positioned properly on the wick adjuster.
- Then begin following the steps outlined in "Adjusting the wick" (page. 7)

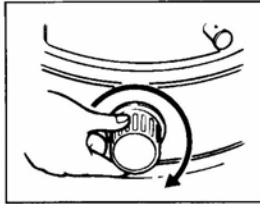

Fig. 14

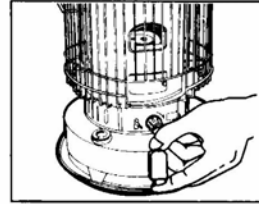

Fig. 15

IGNITION VIA MATCH

If you encounter a problem with the ignition mechanism, or if you have dead batteries, it is possible to light the heater with a match(Fig. 16).

The procedure is as follows:

- Turn the wick adjuster knob clockwise until the wick has been raised to its maximum height.
- Lift the burn chamber by using the burner knob.
- Touch a lighted match to the exposed top edge of the wick.
- Once you see that the wick has been lit, lower the burn chamber back down over the wick.
- Rotate the burner knob from side to side a few times to make sure that the burner is positioned properly on the wick adjuster.
- Then begin following the steps outlined in "Adjusting the wick" (page. 7)

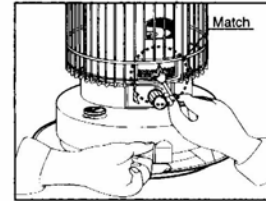
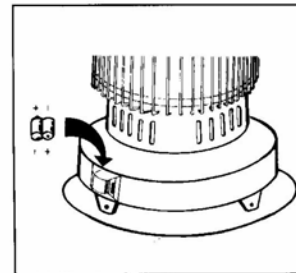
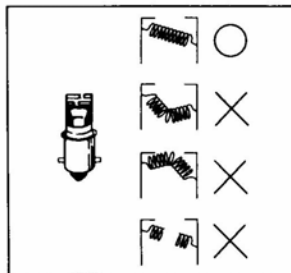
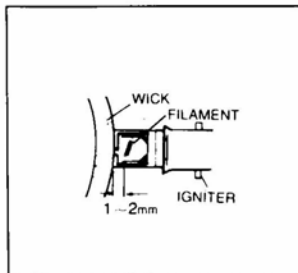

Fig. 16

CAUTION : Make sure that you do not leave the match, or any portion of it (match head, etc.) in the burner area. Debris left from the match can cause an uneven alignment of the burner and may result in smoke, incomplete combustion, odor, or fire.



NEVER LEAVE THE HEATER UNATTENDED WHILE BURNING!

7 CHECKING THE IGNITION SYSTEM

If the automatic ignition system fails to operate properly, perform the following checks:

- **BATTERIES** - 2 "C" cell batteries are located at the rear of the heater. Replace with new batteries.
- **IGNITER PLUG** - If the automatic ignition system still doesn't work after replacing the batteries, check the igniter plug. If the glow coil filament is broken, bent, or doesn't glow when engaged via the ignition lever, it must be replaced. **CAUTION: Be sure igniter plug is Type "B", 2.5V DC, 1A only.**

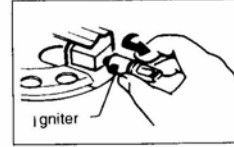

Fig. 17

To replace the igniter plug (Fig. 17) :

- Remove the batteries.
 - Remove the 2 cabinet screws and lift off the cabinet and grille assembly.
 - Pull the ignition lever to raise the igniter plug.
 - Push the igniter plug in and turn in a **clockwise** direction to remove.
 - Install a new igniter plug (Type "B", 2.5V DC, 1A only) by pushing it in and turning it in a **counter-clockwise** direction.
 - Reassemble the heater and replace the batteries.
- TEST IGNITION — Using the wick adjuster knob, raise the wick to its maximum height. Pull the ignition lever.
The igniter plug should be within 1 - 2mm of the wick when the ignition lever is fully engaged.

8 ADJUSTING THE WICK

After lighting the heater, it is important to check the heater flame within the first 5-7 minutes of operation. During the first 5 minutes after ignition, the burner chamber warms up and flames will become visible at the top of burner. These flames will gradually build up. After 5-7 minutes of operation, you should use the wick adjuster knob to obtain the proper flame height. The proper flame height is a flame of no more than 1/2" at the top of the burner, with an even distribution of flame around the flame spreader disk which is positioned in the center of the top portion of the burner. See pictures below for reference.

As you continue to operate the heater, the temperature of the heater and the temperature of the room will continue to change. As the heater warms up, the kerosene in the tank will vaporize faster, and this could require adjusting the wick adjuster down in order to maintain the desired 1/2" flame height. Therefore, it is necessary to continue to monitor the flame height, and to make adjustments using the wick adjuster knob to keep the proper flame height. It is recommended that the heater be checked every 30 minutes in order to keep the proper adjustment because periodic adjustment is required.

Fig. 18

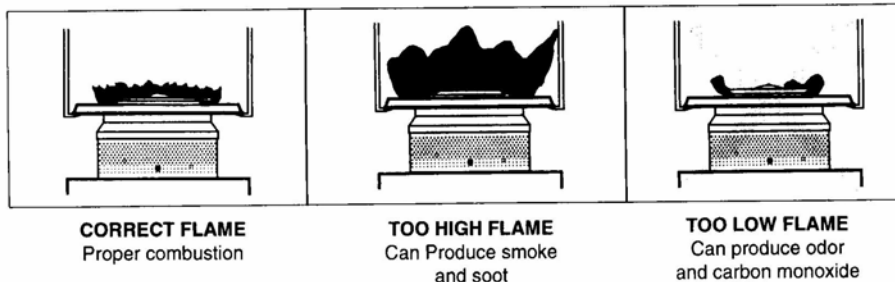

IMPORTANT NOTE : NEVER LEAVE THE HEATER UNATTENDED WHILE BURNING.

Always make sure to turn the heater off and inspect it to insure that it is completely extinguished prior to going to bed.

NEVER LEAVE THE HEATER
UNATTENDED WHILE BURNING!

NOTE : During start-up, small adjustments to the flame can be performed by using the burner knob on the front of the burner and **MOVING THE BURNER FROM SIDE TO SIDE** until the flame at the top of burner is as even as possible. **DO NOT TOUCH THE BURNER KNOB ONCE THE HEATER HAS REACHED NORMAL OPERATING TEMPERATURE AND THE FLAME HAS STABILIZED. THE BURNER KNOB IS VERY HOT DURING OPERATION.**

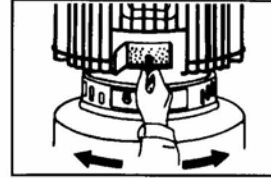

Fig. 19

IMPORTANT NOTE : This heater is designed to operate with a flame height of no more than 1/2" at the top of the burner. For proper combustion to occur, it is **very important** that the flame height be adjusted so that it is neither too high, nor too low. Operating the heater at a wick setting below the minimum recommended setting (the wick-stop setting) could result in the risk of fire and / or carbon monoxide poisoning.

NOTE : If you find that the wick will not raise, push the safety reset lever (see diagram on P.2) to engage the safety shut-off device. Then dial the wick up via the wick adjuster knob.

WARNING : RISK OF INDOOR AIR POLLUTION AND FIRE, DO NOT OPERATE HEATER AT WICK SETTING LOWER THAN MINIMUM WICK-STOP SETTING.

9 WICK MAINTENANCE

Carbon and tar will build up on the top of wick after the heater has been in use for a while. It is very important that the carbon and tar build up be removed in order for the heater to burn properly, and in order for the heater to properly extinguish. After every 2-3 tankfuls of fuel, check the top of the wick. If it feels hard and brittle, there is a build up of carbon on the wick. You might even observe a coating of black carbon on the top of the wick. A wick that is in good condition will feel soft.

There are other checks you can perform to determine if there is a build up of carbon on the wick. If it is difficult to turn the wick adjuster knob, if it is hard to ignite the heater, if it is difficult to obtain the proper wick height, these are signs that there may be a build up of carbon on the top of the wick. To eliminate the carbon build up from the top of the wick, perform the "Carbon Removal / Dry Burning" procedure outlined in the next section.

10 CARBON REMOVAL / DRY BURNING

The "Carbon Removal / Dry Burning " procedure creates a strong odor. Therefore, this procedure should always be performed outdoors on a windless day. You can consider using a porch or other well ventilated area. but keep in mind the fact that a strong odor is produced.

Carbon Removal Procedure :

- As the fuel level in the heater approaches empty, continue to burn the heater without refilling. Once the tank becomes empty and the flame starts to burn out, raise the wick to its maximum height and leave it burning until it burns out completely. After it has burned out, wait 30 minutes, reignite the wick (use a match, if necessary), and allow it to burn out again. Once it has cooled off, use a small brush or an old toothbrush to remove any ash that remains.

- This procedure should remove the carbon from the top of the wick. The wick should feel softer. If some parts of the wick still feel stiff, pinch these sections with a pair of small pliers. This will break up any remaining carbon into small pieces. Once you have done this, add a small amount of kerosene to the tank and repeat the "Carbon Removal" process again. After completing the "Carbon Removal" procedure, refill the tank and wait at least 30 minutes before reigniting the heater.

You should perform the "Carbon Removal" procedure within 7 days of your first use of the heater. After that, the "Carbon Removal" procedure should be performed whenever the build up of carbon causes the wick to become stiff. **"CARBON REMOVAL" SHOULD BE DONE EVERY WEEK DURING THE HEATING SEASON.** IT MAY BE NECESSARY TO DO IT MORE OFTEN DEPENDING UPON THE CARBON BUILD UP ON THE WICK. CHECK THE WICK FREQUENTLY TO DETERMINE WHEN TO DO THE "CARBON REMOVAL" PROCEDURE.

NEVER LEAVE THE HEATER UNATTENDED WHILE BURNING!

11 WICK ASSEMBLY- Check at least once a month !!

The burner assembly sits on top of the wick guide. Over time, tar deposits can accumulate on the wick guide, and this can prevent the burner assembly from seating properly. This can result in poor combustion, smoke, odor, etc.. To prevent this from happening, tar deposits on the wick guide can be removed as follows :

- Making sure that the heater is both cool and turned off, lower the wick to the "off" position.
- Remove the batteries (located at the rear of the heater).
- Remove the 2 cabinet screws. Lift off the cabinet and grille assembly as shown in illustration (Fig. A).
- Using the wick adjuster knob, raise the top of the wick until it is even with the top of the wick guide. Using a flat-edge screwdriver, scrape off the tar deposits. Be careful not to allow any of the tar deposits to drop into the grooves of the wick guide. A small vacuum cleaner can be used to remove the tar deposits that have been scraped off (Fig. B).
- Reassemble the heater and replace the batteries.

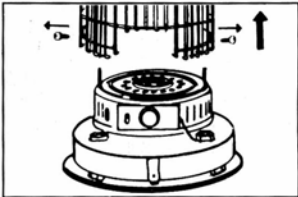

Fig. A

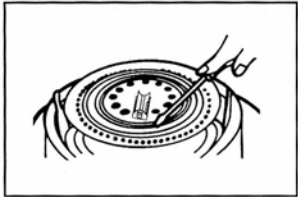

Fig. B

12 WICK REPLACEMENT

The wick in your heater needs replacing if, after repeated cleanings, any of the following conditions still exist: slow to light, hard movement of the wick adjuster knob, kerosene odor while burning, low heat output, slow warm up, damaged wick.

Use only a genuine replacement wick.

REPLACEMENT WICK NUMBER : Kero-World 32225, Dura Heat DH-145, Pick-A-Wick PW-72.

If cleaning the Wick does not improve performance, you will need to replace the Wick Refer to the "TROUBLE SHOOTING GUIDE", see page 14. which outlines conditions under which the Wick should be replaced.

CAUTION : Use ONLY a genuine Replacement Wick. Part Number : Kero-World 32225, Dura Heat DH-145, Pick-A-Wick PW-72. DO NOT attempt to substitute any other type of Wick device or a Wick designed for another brand or model heater. You could damage the heater and create a potential fire hazard.

ATTENTION : The only tools needed to replace the Wick are :

- A Pair of Pliers
- A Flat blade Screwdriver
- A Plastic Bag with a Twist Tie

1. Push down the manual shut-off knob and turn the Wick Adjustment Knob COUNTERCLOCKWISE in the direction of "OFF".

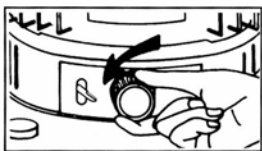

2. Use Pliers to loosen and remove cabinet screws on either side of the Heater Cabinet.

3. Use the Carrying Handle to lift the Cabinet straight up and away from the heater.

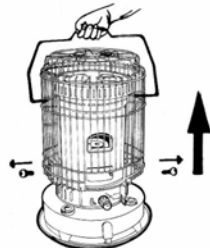

4. Gently pull the Wick Adjustment Knob off the heater.

5. Remove the Cabinet Base by lifting it from the back and tilting it forward to clear the Wick Adjuster Assembly.

6. Trip the Pendulum on the Automatic Safety Shutoff System to activate it.

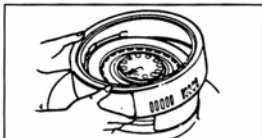
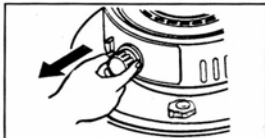

NEVER LEAVE THE HEATER UNATTENDED WHILE BURNING!

7. Remove the four wing nuts which hold the Wick Assembly to the heater and carefully lift the Wick Assembly from the heater.

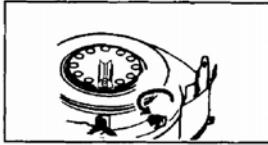

8. Replace the Wick Adjustment Knob temporarily. Turn the Knob **CLOCKWISE** to raise the Wick.

9. While still holding the Wick Assembly up-side-down, grasp the Wick Cover firmly and **PULL** it off with a sharp tug. **CAUTION:** The inside of Wick cover has sharp teeth. The use of work gloves is suggested to avoid injury.

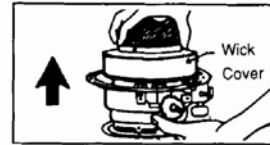

10. Remove the Wick while folding it to the inside. Remove the Wick Sleeve together with the Wick.



11. Reinstall a new wick and insert the 3 pins on a new Wick into the 3 holes on the Wick Sleeve in the upward direction. (See the marked "↑ up" on the Wick Sleeve.)



12. Push the new Wick into the retainer teeth of the Wick Sleeve so that the wick adheres tightly around the inside of the Wick sleeve so that it is not loose anywhere.

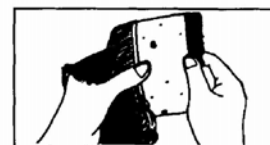

NOTE: DO NOT DISASSEMBLE THE STAINLESS STEEL WICK HOLDER.

13. While pressing each of the three pins of the Wick (attached to the Wick sleeve) toward the inside, insert the three Pins into the slanted grooves of the Wick Guide. Press on each of the three pins, inserting them securely in the holes.



NOTE: Turn the Wick adjustment Knob and check that the Wick moves up and down.

14. The Wick height will automatically be set to the correct burning height of 3/8" (10mm).

NOTE: Be sure to check Wick height it should be 3/8" (10mm).

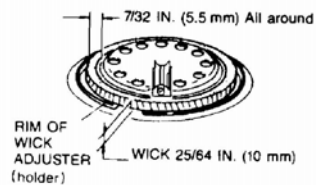
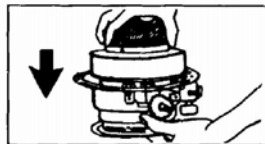

**NEVER LEAVE THE HEATER
UNATTENDED WHILE BURNING!**

15. Turn the Wick Assembly upside down to replace the Wick Cover.
16. Align the tabs on the wick cover with the four screw holes on the Bottom of the Assembly, as shown, and snap it into place. Be certain of firm contact at all points.

17. Turn the Wick Adjustment Knob to the fully raised position. Pull lightly on the skirt of the Wick to remove any slack. Press lightly to secure the skirt to the Retainer Teeth on the Wick Cover.



18. Replace the Wick Assembly on the heater with the Wick raised. Be sure the rubber seal on tank is properly seated. You will need to hold the knob in the clockwise position to keep the Wick raised. The Wick adjuster knob will need to be positioned between the Caution and Warning labels. Replace two diagonally opposite Wing Nuts first, then the remaining two. Tighten each of the four Wing Nuts gradually until the Wick assembly is firmly in place.

19. While your heater is disassembled, check the Automatic Safety Shutoff system. Trip the Automatic Shutoff System by nudging the Pendulum. Raise the wick by turning wick adjuster knob. Trip it again to make certain it is operating correctly.

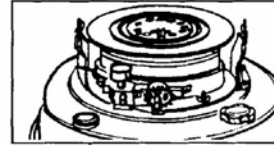
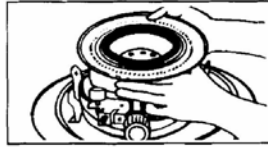
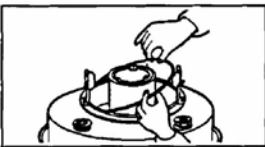

20. Turn the Wick Adjustment knob to test its operation. Be certain the Wick operates smoothly as the Knob is turned CLOCKWISE and COUNTER-CLOCKWISE.
21. Test Ignition. Raise the Wick to its full height. The Ignition Plug should be within 3/64" to 5/64" (1mm to 2mm) of the Wick when the Lever is pulled.
22. Remove Wick Adjustment Knob which you had temporarily replaced to test Wick operation.
23. Replace the CABINET BASE making certain to align the Automatic Safety Shut-off System Lever and the Wick Adjustment Shaft, which holds the Knob, with the appropriate slots in the CABINET BASE. Begin by aligning them and gently snap the CABINET BASE in place over the Wick Assembly.
24. Replace the heater Cabinet. Make certain the Guard Grille prongs are inserted securely into the proper holes on the heater, and the Front Cabinet matches the front of the heater.
25. Fasten the Cabinet to the heater with the two screws.
26. Replace the Wick Adjustment Knob. To be certain it is properly positioned on the Wick Adjustment Shaft, raise the Wick to its full height.
27. Be sure to check that the wick is set at the correct height of 3/8"(10mm) after reassembling the heater.

**NEVER LEAVE THE HEATER
UNATTENDED WHILE BURNING!**

13 EXTINGUISHING THE HEATER

To extinguish the heater, push down on the manual shut-off knob (Fig. 20) with one hand while holding the wick adjuster knob in the other hand. You will feel the pressure of spring action attempting to turn the wick adjuster knob in a counterclockwise direction

in your hand. By slowly relaxing your grip on the wick adjuster knob, you will allow the spring to gradually lower the wick and extinguish the flame. When there is no further pressure from the spring action, confirm that the wick has been fully lowered by turning the wick adjuster knob in a counter-clockwise direction as far as it will go. After 10-15 seconds, open the door on the body of the heater, lift the burner using the burner knob, and visually confirm that there are no flames present. This will confirm that the heater is completely extinguished.

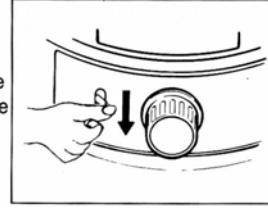

Fig. 20

CAUTION : After extinguishing the heater, **allow at least 10 minutes before reigniting the heater.** This allows the heater time to cool off and return to a normal temperature. Failure to allow the 10 minute cooling off period before reigniting the heater will result in the creation of a strong odor and possible flare-up.

WARNING : Carbon and tar can build up on the wick after the heater has been in use for a while. This can interfere with the ability of the wick to be lowered into the body of heater, and can result in the flame not extinguishing completely. It is the responsibility of the owner to inspect the wick, to maintain proper maintenance of the wick, and to replace the wick when necessary in order to prevent the build up of carbon and tar from creating a dangerous situation where the heater does not fully extinguish.

14 AUTOMATIC SAFETY SHUT-OFF DEVICE

This heater is equipped with an automatic safety shut-off device. The purpose of this device is to quickly and efficiently shut-off the heater should the heater be jarred or tipped over while in operation. This is the main safety system that is built into the heater, and it functions to prevent the flame from spreading if the heater is knocked over.

The automatic safety shut-off device is built into the mechanism that raises and lowers the wick. It has been designed so that if the pendulum is jarred by a shock of some sort, it retracts a latch from the wick control shaft ratchet, and a torsion spring reacts to drop the wick to its fully lowered position. This rapid lowering of the wick extinguishes the flame.

If you find that the wick will not raise, push the safety reset lever (see diagram on P.2) to engage the automatic safety shut-off device. Then dial the wick up via the wick adjuster knob.

IMPORTANT NOTICE : For the safety shut-off device to function properly, the wick must be free of carbon and tar deposits. Regularly performing the "Carbon Removal / Dry burning" procedure described in the "Wick Maintenance" and "Carbon Removal / Dry Burning" sections on page 10 is very important to the proper functioning of this important safety device.

IMPORTANT NOTICE : PLEASE CHECK THE SAFETY SHUT-OFF DEVICE ONCE A WEEK DURING THE HEATING SEASON TO INSURE THAT IT IS FUNCTIONING PROPERLY.

IMPORTANT NOTICE: EVERY TIME THE WICK IS REMOVED OR REPLACED, THE SAFETY SHUT-OFF DEVICE MUST BE TESTED TO INSURE THAT IT IS FUNCTIONING PROPERLY.

**NEVER LEAVE THE HEATER
UNATTENDED WHILE BURNING!**

TESTING THE SAFETY SHUT-OFF DEVICE : At least once a week during the heating season, it is important to test the safety shut-off device to be sure that it is operating properly. **WITH THE HEATER TURNED OFF**, raise the wick using the wick adjuster knob to the fully raised position. Grabbing the protective grille, give the heater a firm shake. If the safety shut-off device is working properly, you will hear a loud noise as the ratchet is disengaged and the torsion spring drops the wick into the body of the heater. To verify that the wick has been completely lowered, turn the wick adjuster knob in a counterclockwise direction. If the safety shut-off device is functioning properly, the wick will have been completely lowered. If you are able to lower the wick further using the wick adjuster knob, this means that it is time to perform the "Carbon Removal Dry Burning" procedure described on page 8 again.

10 LONG TERM STORAGE OF YOUR HEATER

Carefully following the instructions for storage given below will insure that your heater will operate efficiently and safely next season (Fig.22/ Fig.23).

- Using a small amount of kerosene, swirl and rinse the inside of the tank. **NEVER mix water with the kerosene** as it will cause rust inside the tank. Pour the kerosene out making sure that you remove it all.
- With the fuel tank empty, ignite the heater. With the wick at its maximum height, keep the wick burning until it burns out completely (about 1 hour). It is a good idea to do this outside or in an extremely well-ventilated area.
- Remove the batteries. Remove the 2 cabinet screws and lift off the the cabinet and grille assembly. Remove the burner. Remove the wick adjuster from the fuel reservoir. Thoroughly dry the inside of the fuel tank. Using a screwdriver and/or a brush, remove any carbon, tar or soot that might have accumulated on the wick adjuster, wick guide or burner.
- After a thorough cleaning, reassemble the heater. It is important when reassembling the wick adjuster to be sure to maintain an equal gap between the wick adjuster and the wick guide cylinder all around. See "Wick Replacement" on page7 for reference.
- Remove the batteries from the battery case before storing the heater to prevent leakage and corrosion.
- Store the heater with the wick in the fully lowered position and the safety shut-off device deactivated.
- Store the heater in the original box with the original packing material and keep the **OWNER'S MANUAL** with the heater. Store in an area that is well-ventilated.

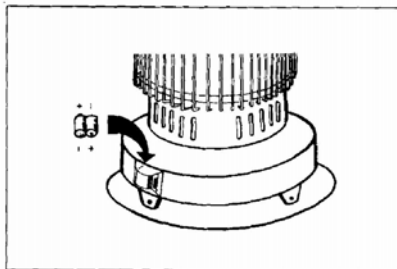

Fig.22

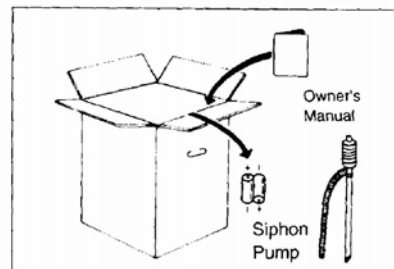

Fig.23

**NEVER LEAVE THE HEATER
UNATTENDED WHILE BURNING!**

17 TROUBLE SHOOTING GUIDE

TROUBLES	CORRECTIVE ACTION
<p><u>Heater Will Not Light ;</u></p> <ol style="list-style-type: none"> 1. Fuel tank is empty 2. Water present in kerosene 3. Igniter plug fails to glow 4. Igniter plug makes contact with side of wick 	<ol style="list-style-type: none"> 1. Fill tank with water-clear 1-K kerosene. 2. Drain tank. Remove wick assembly & replace wick. Reinstall wick assembly. Fill tank with water-clear 1-K kerosene. 3. Replace batteries. Replace igniter plug. Check for broken or disconnected wire. 4. Lower wick using wick adjuster knob until igniter plug makes contact with top of wick.
<p><u>Heater Produces Smoke or Odor ;</u></p> <ol style="list-style-type: none"> 1. Flame is too high 2. Heater is in an air draft 3. Burner is not level 4. Carbon or tar built up on wick 5. Contaminated kerosene 	<ol style="list-style-type: none"> 1. Using wick adjuster knob, lower wick to desired 1/2" flame. 2. Move heater out of air draft. 3. Using burner knob, rotate burner from side to side until it seats properly over wick. 4. Perform "Carbon Removal / Dry Burning" procedure. Replace wick if necessary. 5. Drain tank. Remove wick assembly & replace wick. Reinstall wick assembly. Fill tank with water-clear 1-K kerosene.
<p><u>Flame Flickers or Dies ;</u></p> <ol style="list-style-type: none"> 1. Water present in kerosene 2. Carbon or tar built up on wick 	<ol style="list-style-type: none"> 1. Drain tank. Remove wick assembly & replace wick. Reinstall wick assembly. Fill tank with water-clear 1-K kerosene. 2. Perform "Carbon Removal / Dry Burning" procedure. Replace wick if necessary.
<p><u>Wick Burning Down Excessively ;</u></p> <ol style="list-style-type: none"> 1. Dangerous, volatile fuel mixed with kerosene (gasoline, benzene, alcohol, white gas, paint thinner, camp, stove fuel, oil compound) 	<ol style="list-style-type: none"> 1. Drain and clean tank <ul style="list-style-type: none"> — Remove and replace wick — Fill tank with water-clear 1-K kerosene.
<p><u>Wick Adjuster Sticks ;</u></p> <ol style="list-style-type: none"> 1. Water present in kerosene 2. Carbon or tar built up 	<ol style="list-style-type: none"> 1. Drain tank. Remove wick assembly & replace wick. Reinstall wick assembly. Fill tank with water-clear 1-K kerosene. 2. Perform "Carbon Removal / Dry Burning" procedure. Replace wick if necessary.
<p><u>Wick will not raise ;</u></p>	<ul style="list-style-type: none"> — Push the safety reset lever (see diagram on P.2) to engage the automatic safety shut-off device. Then dial the wick up via the wick adjuster knob.
<p><u>Heater is enveloped in flames ;</u></p>	<ul style="list-style-type: none"> — Call Fire Department. — Smother flames with fire extinguisher or sand. Otherwise smother flames with blankets and then throw water on blankets. Do not throw water directly on the heater itself.

NEVER LEAVE THE HEATER UNATTENDED WHILE BURNING!

17 PARTS LIST

DRAWING NUMBER	DESCRIPTION	PART NUMBER
1	TOP GRILLE	08-5423
2	CARRYING HANDLE	08-5697
3	TOP PLATE	08-5123
4	BURNER ASS'Y	08-0123
5	WICK COVER	08-9622
6	REAR GRILLE	08-5429
7	CABINET BASE	08-5323
8	WIND COVER	08-9624
9	WICK ADJUSTER ASS'Y	08-1023
10	WICK	See Specs Below
11	WICK ADJUSTER GASKET	08-4624
12	SAFETY SHUT OFF DEVICE	08-3026
13	DRIP TRAY ASS'Y	08-5223
14	FUEL CAP GASKET	REF.
15	FUEL CAP ASS'Y	08-4230
16	WICK ADJUSTER KNOB	08-1724
17	BATTERY CASE ASS'Y	08-2197
18	FRONT GRILLE	08-5425
19	CABINET	08-5020
20	MICA WINDOW	604B
21	DOOR	08-5723
22	DRAFT TUBE TOP	REF.
23	FUEL GAUGE	08-4897
24	FUEL GAUGE GASKET	REF.
25	TANK ASS'Y	08-4020
26	IGNITER ASS'Y	08-2495

18 EXPLODED PARTS DRAWING

NOTE: SPECIFY MODEL NUMBER AND PART NUMBER WHEN ORDERING PARTS.

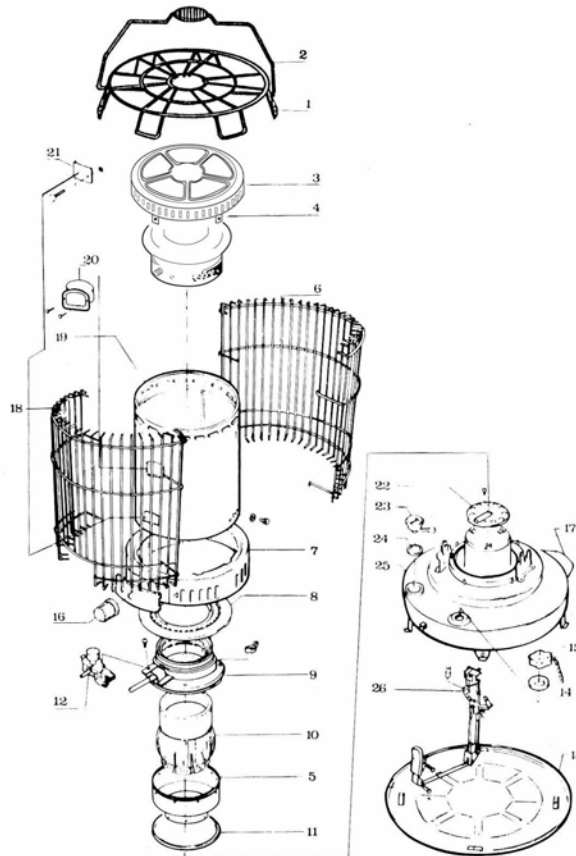

19 SPECIFICATIONS

Model No.		DH 2302
Type of Heater		Convection
Heat Output		Max. 23,000 BTU/hr
Fuel Tank		Integral
Tank Capacity		1.9 U.S. gallons
Continuous Combustion Time		Approx. 8-12 hr.
Max. Fuel Consumption		0.167 U.S. gallons/hr.
Ignition Method		Battery-C Cell x2, Igniter Type "B"
Weight(empty)		Approx. 29.3 lbs.
Dimensions	Height	26.8 inches
	Width	18.7 inches
	Depth	18.7 inches
Wick Height		25/64 IN. (10mm)
Replacement Wick Number		Dura Heat DH-145, Pick-A-Wick PW-72, Kero-World 32225