

TOYOTOMI

PORTABLE KEROSENE HEATER OPERATION AND MAINTENANCE INSTRUCTIONS

MODEL **Omni 230**

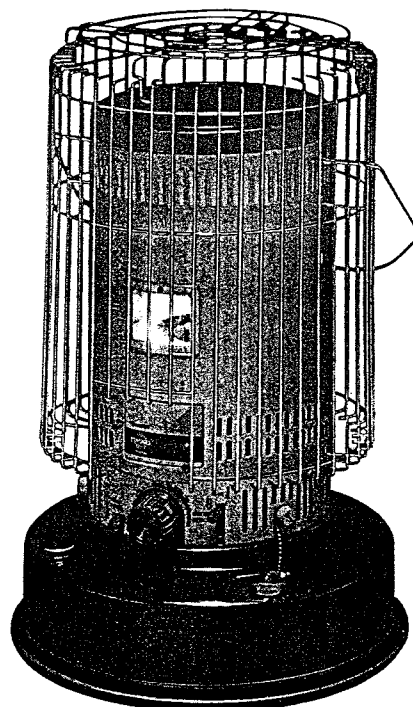

IMPORTANT

READ AND UNDERSTAND INSTRUCTIONS BEFORE USING HEATER.
RETAIN INSTRUCTIONS FOR FUTURE REFERENCE.

CONTENTS

SAFETY TIPS	1	ASSEMBLY AND OPERATION	6
FUEL GUIDE	3	CARE AND MAINTENANCE	11
OPERATING CONTROLS AND FEATURES ...	4	REPLACEMENT OF PARTS	12
SPECIFICATIONS	5	STORAGE	15
COMPONENT PARTS	5	TROUBLESHOOTING	16

Congratulations; you are ready to begin enjoying the benefits of one of the most popular kerosene heaters ever made. TOYOTOMI, the leader in kerosene heater technology, has tested and refined the Omni 230 to assure you of long-term safety and satisfaction. Please study the following instructions, use and care for your heater carefully, and it will serve you well for many years.

SAFETY TIPS

BEFORE OPERATING YOUR HEATER, PLEASE review these safety tips:



RISK OF EXPLOSION

1. Never use any fuel other than water-clear kerosene (ASTM No. 1-K kerosene).
Never use gasoline. Use of gasoline can lead to uncontrollable flames resulting in destructive fire. Even kerosene contaminated with small amounts of gasoline, or similarly volatile materials, can be hazardous. Never use a can for kerosene that has previously been used for gasoline, paint thinner, or solvents.
2. Never refill heater fuel tank when heater is operating or still hot. To do so may cause a "flash back" of flame to the fuel container, resulting in injury to yourself and your property.
3. Never use heater in areas where flammable vapors or gases may be present. Especially avoid use of heater where gasoline, naphtha, acetone or other volatile solvents are in the air, or whose containers are open. Such vapors could be ignited by the heater, resulting in fire and/or explosion.
4. Never fill heater fuel tank in living space. Fill heater tank outdoors. Never overfill your heater. Always replace heater tank cap securely after refueling. Spillage of kerosene produces strong odor which is hard to remove. Spillage on carpet can be ignited if match or some other ignition source contacts it.
5. Never store or transport kerosene in other than a metal or plastic container that is (1) acceptable for kerosene, (2) non-red in color, and (3) clearly marked, "KEROSENE". Never store kerosene in the living space. Picking up a gasoline can by mistake when fueling is a major cause of heater fires.

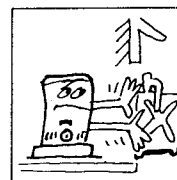
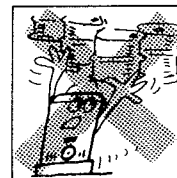
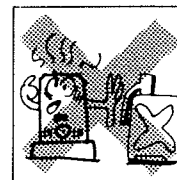
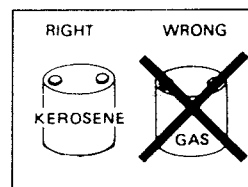

RISK OF BURNS OR FIRE

1. Observe the heater carefully for 15-20 minutes after start-up. Problems of improper adjustment of wick height or improperly seated heat chamber should become evident during this warm up period.

NOTE: Carefully follow the instructions for lighting and adjusting the flame.

2. Due to high surface temperatures, keep away from children, furniture and clothing.
3. Do not operate heater without protective guards completely attached.

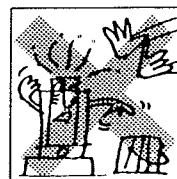

4. Do not use heater to heat or boil water or as a cooking appliance. Do not place cooking utensils, tea kettles or any other object on top of heater while in operation.
5. To avoid possible burns or fire, do not move, refuel or attempt to service your heater while it is burning or still hot. If the heater is dropped while it is burning, fuel spillage and flames outside the heater may occur.
6. Do not operate heater less than three (3) feet from walls, draperies, clothing, or furniture. The operation of any heating appliance too close to such materials could cause them to ignite, possibly resulting in a serious fire.
7. To avoid unstable burning, do not operate your heater in areas exposed to strong drafts. Do not operate heater in high-traffic areas such as doorways or hallways where it may be touched, jarred or tipped accidentally.
8. Do not operate heater in direct sunlight to avoid overheating, which may cause abnormal flame behavior. Do not allow room temperature to go above 80°–85°F. If the room temperature exceeds 80°–85°F the flame may increase, thereby producing smoke.
9. Before going out, or at bedtime, turn the heater off, making sure the wick is in its lowest position (see Extinguishing the Flame on page 10) and flame is completely extinguished.

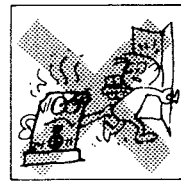
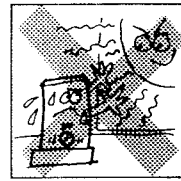
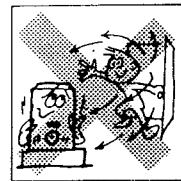
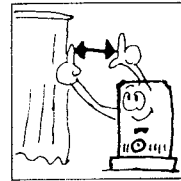
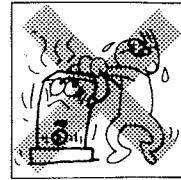
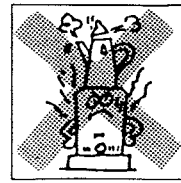

WARNING

RISK OF INDOOR AIR POLLUTION

Use heater only in well-ventilated areas. People with breathing problems should consult a physician before using the heater.

“In a house of typical construction, that is, one that is not of unusually tight construction due to heavy insulation and tight seals against air infiltration, an adequate supply of air for combustion and ventilation is provided through infiltration. However, if the heater is used in a small room where less than 200 cubic feet (5.7 m³) of air space is provided for each 1000 Btu per hour of heater rating (considering the maximum burner adjustment), the door(s) to adjacent room(s) should be kept open or a window to the outside should be opened at least 1 inch (25.4 mm) to guard against potential buildup of indoor air pollution. Do not use the heater in a bathroom or any other small room with the door closed.”

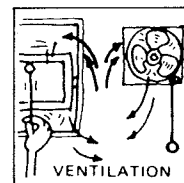

FUEL GUIDE

The TOYOSET Omni 230 is designed for use with high-quality kerosene only. Use of low-quality kerosene will cause wick performance to drop, leading to "low flame" and "odor problem" conditions.

Purchase only 1-K kerosene in non-red cans reserved exclusively for kerosene and marked accordingly with the word "KEROSENE". Always store your kerosene in a separate area from where you store gasoline for your power equipment, to avoid use of gasoline in your heater.

What to Buy . . .

ALWAYS : Crystal clear, colorless, high quality KEROSENE, ASTM No.1-K.

ALWAYS : Kerosene free of contaminants, water or cloudiness.

NEVER : Gasoline, alcohol, white gas, camp stove fuel or additives.

NEVER : Yellow or sour-smelling fuel.



How to Use It . . .

ALWAYS : Fill heater away from living quarters when heater is cool; use siphon.

ALWAYS : Check wick frequently for tar build-up. (Rapid, heavy build-up may indicate poor quality or deteriorated fuel.)

ALWAYS : Watch fuel gauge to avoid over-filling heater.

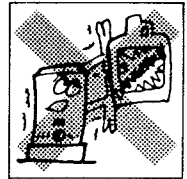

How to Store It . . .

ALWAYS : In a clean container, clearly marked KEROSENE.

ALWAYS : AWAY FROM direct sunlight, heat sources or extreme temperature changes.

NEVER : In a glass container, or one that has been used for other fuels.

NEVER : For longer than 6 months. (Begin each heating season with fresh kerosene; discard at the end of the season.)

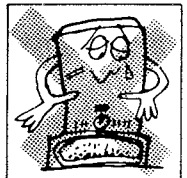
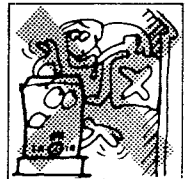

Why It is Important . . .

Pure, clean kerosene is essential for safe and efficient heater operation. Poor quality or contaminated kerosene can cause:

- Low flame
- Excess tar deposits on the wick
- Reduced wick life
- Odor, smoke
- Difficulty in igniting or extinguishing flame

Use of a highly volatile flammable fuel such as gasoline can produce uncontrollable flames, creating a severe fire hazard.

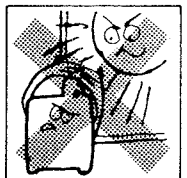

CAUTION

Flames observed emerging from the heater body are a clear indication that fuel is dangerously contaminated with gasoline or other highly flammable material. If this occurs,

- a. Never attempt to move the heater.
- b. Call the Fire Department.
- c. Use only a class "B" fire extinguisher.
- d. Never throw water directly on a burning heater.

OPERATING CONTROLS AND FEATURES

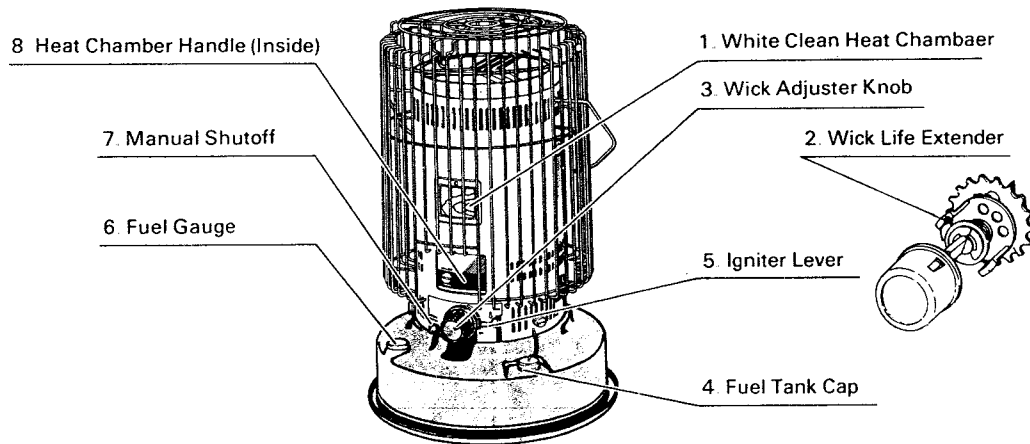

- 1. **White Clean Heat Chamber:** Permits high heat output capacity without increasing unwanted combustion materials.
- 2. **Wick Life Extender:** Helps maintain good wick performance.
- 3. **Wick Adjuster Knob:** Used to raise and lower wick for heat output adjustment. Includes wick stop mechanism that indicates effective wick height range. To extinguish flame, press red button and turn knob counterclockwise.
- 4. **Fuel Tank Cap:** Covers filling port of fuel tank. Cap is secured to heater by chain.
NOTE: Wipe away any spilled kerosene from tank after filling.
- 5. **Igniter Lever:** Battery-powered electrical igniter is brought in contact with to ignite fuel at start-up.
NOTE: Lever should be pushed down gently.
- 6. **Fuel Gauge:** Indicates fuel level in tank.
NOTE: Never fill beyond black line.
- 7. **Manual Shutoff:** Used to rapidly retract wick and extinguish flame.
NOTE: To avoid odor and smoke, do not use routinely to turn heater off.
This manual shutoff is not effective when gasoline, gasoline-contaminated kerosene, or other highly flammable fuels are used in the heater.
- 8. **Heat Chamber Handle:** Used to check and insure proper seating of the heat chamber after ignition. Improper seating of the heat chamber will cause erratic flame and smoke.
- 9. **Unique Wick Design:** Triple wick construction combines specially-woven fibers for uniform shape, strength and controlled kerosene absorption; chemically-treated cotton fiber for water resistance, and a vapor barrier for smooth wick retraction.

SPECIFICATIONS

TOYOSET Portable Kerosene Heater Model Omni 230

Heat rating	23,000 BTU/h
Fuel tank capacity	1.99 Gallons
Burning time/tank*	12-16 Hours
Size (W×H×D)	17-3/8" × 26" × 17-3/8"
Weight	25.6 Lbs.
Wick adjuster	Wick life extender mechanism
Igniter	Automatic, powered by two (2) "C" size batteries

* Depending on wick setting, condition and fuel quality.

COMPONENT PARTS

REF #	PART #	PART NAME
1.	20457701	Top plate
2.	20452303	Top guard assembly
3.	22742863	Screw 1P
4.	20452352	Front guard assembly
5.	20452358	Rear guard assembly
6.	22746204	Carrying handle
7.	22748305	Thumbscrew for cover
8.	24057707	Outer cover assembly
9.	20457731	Mica window
10.	22741532	Screw for mica window
11.	20457754	Access door
12.	20457708	Heat chamber assembly
13.	20457711	Wick adjuster with pendulum assembly
14.	22748312	Wick adjuster knob
15.	22741513	Glass fiber wick
16.	22741514	Wick sleeve
17.	22741515	Rubber packing
18.	20457716	Pendulum assembly
19.	20450017	Screw 1A
20.	20451618	Igniter coil
21.	20457719	Igniter unit
22.	20450120	Screw for igniter unit
23.	20457722	Fuel tank assembly
24.	20452223	Fuel gauge
25.	20450124	Fuel tank cap
26.	22748427	Battery holder
27.	20457767	Battery holder cover
28.	20450030	Screw for tray
29.	20450028	Manual fuel siphon
30.	20457729	Drip tray
31.	20450040	Wing nut
32.	20450041	E ring
33.	20457743	Primary air tube cover
34.	20457746	Wick height adjuster knob
35.	20450047	E ring (L)
36.	20459548	Spring for wick height adjuster
37.	20450049	Washer for wick height adjuster
38.	22741550	Cross pin
39.	20452353	Top guard retainer
40.	20457794	Instruction manual
41.	20457798	Carton

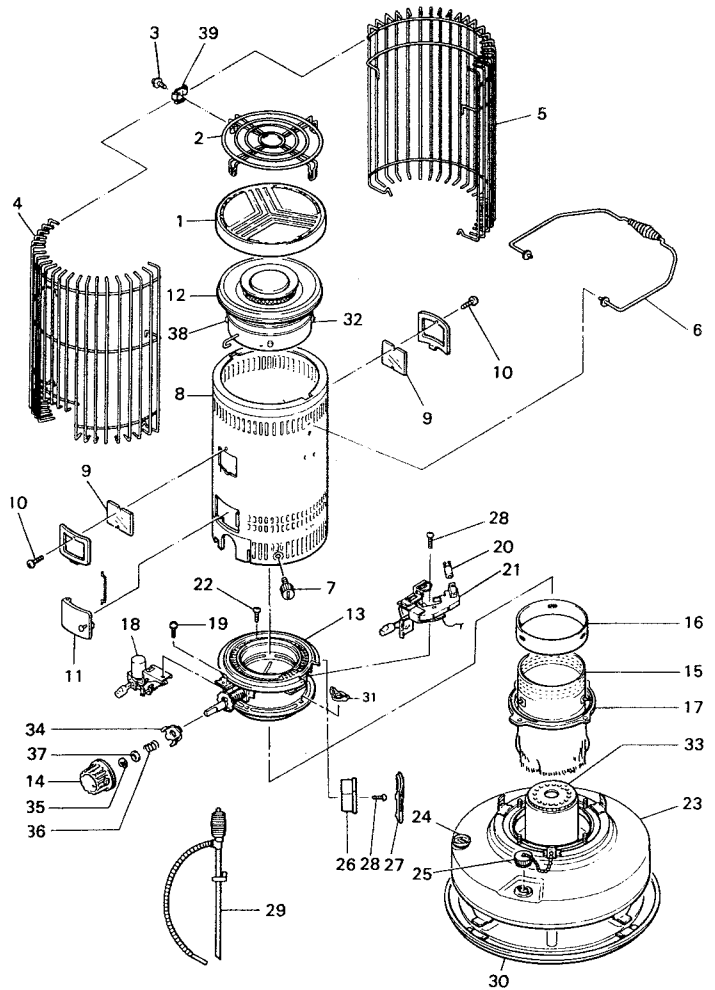

Make a note of your heater's serial number. The serial number is located on the outside surface of fuel tank or cabinet. If you need replacement parts or service in the future, reference to this number will assure you of obtaining the proper parts quickly.

Your heater's serial number

SERIAL NO.

ASSEMBLY AND OPERATION

INSPECTION AND ASSEMBLY

NOTE: Save the shipping carton and packing materials for future storage of your heater.

1. REGISTRATION CARD

Remove the registration card from the shipping carton, fill it out and mail as soon as possible.

2. REMOVE PACKING MATERIALS AND INSTALL TOP GUARD

Remove all packing materials from your heater and install the top guard as follows:

CAUTION: Risk of burns. Do not operate heater without guard completely attached.

Refer to guard installation instructions enclosed.

a) Remove front guard (A) and rear guard (B) from heater.

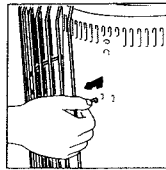

b) Align two (2) tabs on inner top plate with slots on top of outer cover. Turn top plate clockwise until it stops.



c) Align ends of prolonged vertical bars of front guard (A) with holes (C) on either side of lower outer cover, and insert.

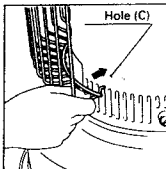

d) Align ends of prolonged horizontal bars of front guard (A) with holes (D) on either side of upper outer cover, and insert. Align and insert rear guard (B) in the same way.

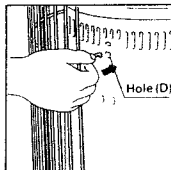

e) Lock top guard retainer into ends of prolonged vertical bars of front and rear guards on each side.

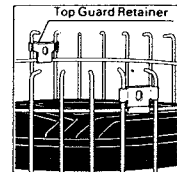

f) Align holes on top guard retainers with screw holes on top guard.

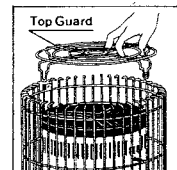

g) Secure with one screw on each side.

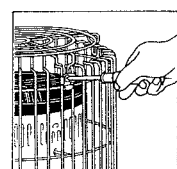

h) Install carrying handle. Guard installation is now complete.

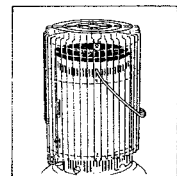

3. INSTALL DRIP TRAY

NOTE: DO NOT operate your heater without the drip tray.

Place the drip tray on the floor.

- Place the heater on the drip tray so the three (3) feet of the heater are next to the three (3) tabs on the tray.
- Turn the heater clockwise until the feet slide into their tabs.

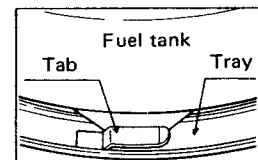

4. INSTALL BATTERIES

Locate the battery holder on the back of your heater. Remove the battery holder door.

- Insert the two (2) "C" size batteries according to the plus (+) and minus (—) markings inside the holder.
- Replace the battery holder door.

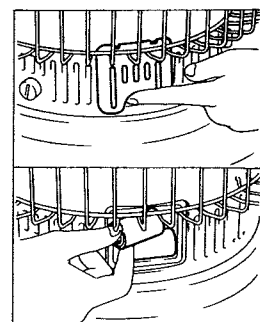

5. CHECK THUMBSCREWS

Make sure that the three (3) thumbscrews around the heater cover above the fuel tank are tight.

FUELING

▲ WARNING: Use only water-clear ASTM No. 1-K kerosene.
Never use gasoline or other flammable liquids.
ALWAYS extinguish heater before refill heater fuel tank.
Fuel heater outside the living area.

1. Insert the straight tube of the manual fuel siphon into the kerosene container. Remove the fuel tank cap on the heater, and insert the siphon's flexible hose into the fuel tank opening.
2. Turn the air vent knob on the top of the siphon clockwise to close the air vent.
3. To start the flow of kerosene, squeeze the bulb of the siphon vigorously six or seven times. Once the flow begins, it is no longer necessary to squeeze the bulb. To avoid overfilling the tank, watch the fuel gauge. As the indicator enters the red zone, stop the flow by turning the air vent knob counterclockwise.

NOTE: Be especially careful to avoid overfilling the tank with very cold kerosene; otherwise overflow might occur when the fuel warms up.

4. Remove the siphon carefully, allowing the excess kerosene to drain from the tube back into container. Replace the fuel tank cap and tighten it securely. Be sure to wipe away any spilled kerosene from tank or other heater parts.

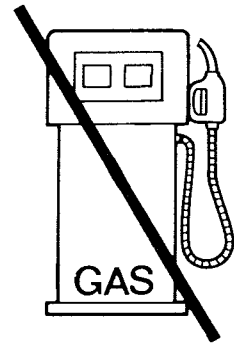

USE KEROSENE ONLY

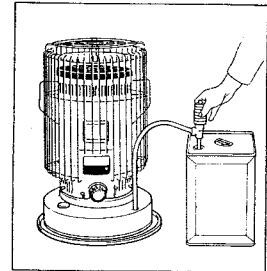

CHECK BEFORE LIGHTING

1. LOCATE YOUR HEATER AWAY FROM WALLS AND AVOID DRAFTS

Allow at least three (3) feet of clearance between the heater and walls, curtains, shelving or other combustible materials. Do not operate your heater in drafty areas or locations where opening doors may create gusts of air. Drafts or strong air currents may make flame unstable and affect heater performance.

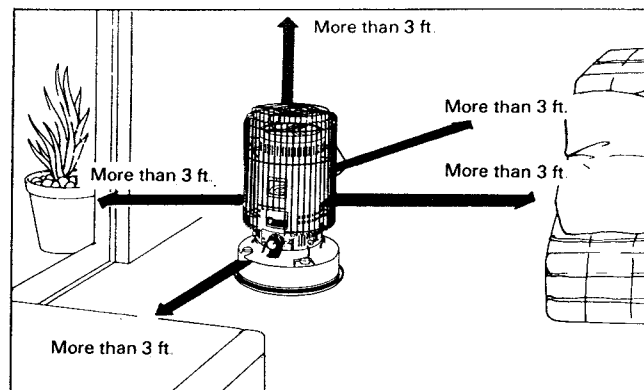

2. LEVEL THE HEATER

The heater should be operated on a firm, level floor.

NOTE: If your heater is not level, change locations. Do not attempt to prop it up with books or other objects. An unlevel heater may burn with an uneven flame.

3. CHECK THE WICK LIFE EXTENDER

When you first use your new heater or after replacing the wick, check if the WICK LIFE EXTENDER is on position ①. If not, readjust the wick life extender mechanism to position ① by following the instructions on page 9, ADJUSTMENT OF WICK HEIGHT WITH WICK LIFE EXTENDER.

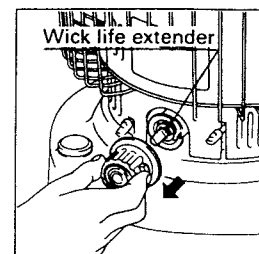

4. ENGAGE THE AUTOMATIC EXTINGUISHER

The automatic extinguisher is engaged automatically by turning the wick adjuster knob clockwise. Check the operation of the automatic extinguisher before lighting your heater. After turning the wick adjuster knob clockwise until it stops, turn the manual shutoff counterclockwise to be sure the wick moves smoothly down.

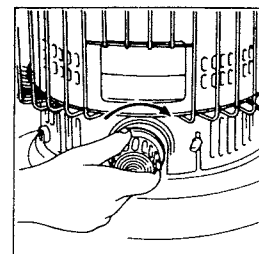

LIGHTING

NOTE: When you first use your new heater, ignite it out of the living area of your house, either in a garage or an outside area protected from strong drafts. Burn it for about 15 minutes to remove all of the protective oil present on the burner parts. If this 15 minute "burn-in" is done inside, some objectionable odor will be observed. This procedure is necessary **ONLY THE FIRST TIME** you ignite your heater.

NOTE: If you have fueled your heater for the first time, or if you are refueling it after it has been out of fuel for a long time, you will need to wait about thirty (30) minutes for the wick to become fully saturated before lighting. Failure to allow enough time for the wick to become fully saturated may cause permanent damage to the wick when it is lighted.

1. Turn the wick adjuster knob clockwise until it stops. This raises the wick to its maximum height. As the wick rises within the heater, the wick adjuster knob turns with some resistance and makes a sound like the winding of a clock. Once the wick has reached its proper height, the automatic extinguisher is fully engaged. The wick adjuster knob will now move freely left or right to adjust the flame.

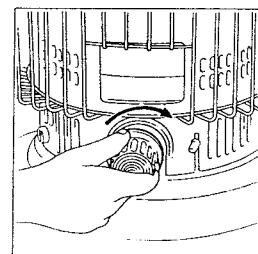

2. AUTOMATIC LIGHTING

Gently push down the igniter lever. The igniter coil should glow and touch the wick. When flame appears, release the igniter lever.

NOTE: If you have difficulty igniting wick, let up on the igniter lever very slightly to remove the igniter coil from direct contact with the wick.

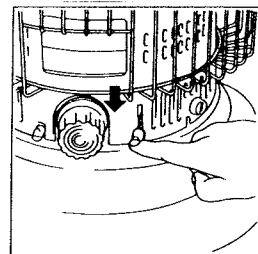

3. LIGHTING WITH A MATCH

You should not have to light the heater with a match, but should it become necessary, open the access door, lift the heat chamber up by holding the wire heat chamber handle and touch the match to the top of the wick. Do not allow burned parts of the match to fall or remain on the wick.

NOTE: To restore the automatic igniter system to proper operation, replace worn-out batteries; or if the igniter coil is defective, replace it.

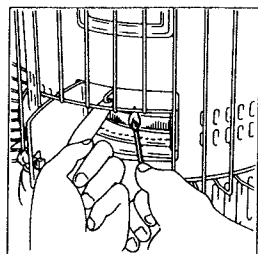

4. Be sure that heat chamber is properly seated by moving the wire heat chamber handle left and right.

NOTE: An improperly seated heat chamber can cause high flame, smoke, and potential damage to the heater itself. Do not leave the heater until you have determined that the flame is burning normally, as described in the following section.

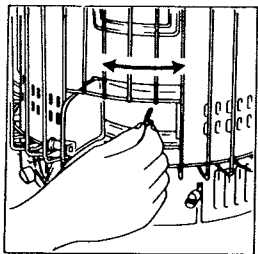

ADJUSTING THE FLAME

1. After lighting, wait for the heat chamber to reach operating temperature. This will take ten-fifteen minutes, after which the flame will be visible through the mica window.

2. CHECK THE FLAME LENGTH

Look at the flame and check its length. Flame length is not necessarily even or uniform around the circumference of the center disk. Some areas may be lower than others, but on maximum wick height, flame length should average between 3/8 inch to 1 inch.

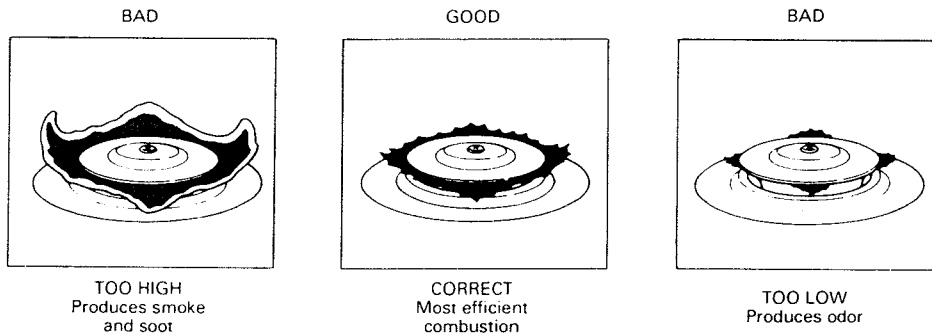

If necessary, raise or lower the wick by turning the wick adjuster knob to produce the proper flame condition.

NOTE: Do not operate your heater with wick set TOO LOW or TOO HIGH. Doing so will decrease combustion efficiency and increase production of unwanted emissions.

NOTE: The wick-stop serves an important purpose. The wick-stop indicates the lowest level at which the wick should be used.

⚠ WARNING: Risk of indoor air pollution and fire. DO NOT OPERATE HEATER AT WICK SETTING LOWER THAN MINIMUM WICK-STOP POSITION.

NOTE: During the first 2-3 days of the heater use, the flame may reach about 1 inch above the top of the heat chamber even at the lowest position (the wick stop position).

NOTE: Always observe the heater closely for the first 15-20 minutes after it is lighted to be sure it is properly adjusted.

3. ADJUSTMENT OF WICK HEIGHT WITH WICK LIFE EXTENDER

Normal use of the wick and heat chamber over a period of time may make it impossible to achieve a satisfactorily high flame level. Usually this occurs because the wick develops deposits on it that retard fuel flow and evaporation. When this happens, the wick should be cleaned by "burning dry" as described in item 2, page 11 "WICK INSPECTION AND CLEANING".

When the "burning dry" cleaning procedure is no longer effective in restoring proper flame height, adjust the wick life extender mechanism to the next higher position.

NOTE: Do not move the wick life extender to a higher position unless the wick has been cleaned by "burning dry".

To adjust the wick height rising the wick life extender, first release the automatic extinguisher by pushing down on the MANUAL SHUTOFF.

Then pull the wick adjuster knob from its shaft by pulling outward.

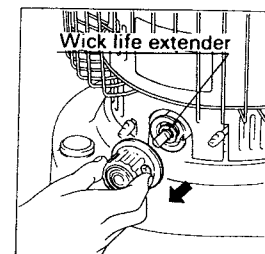
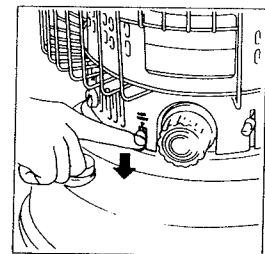

When the wick adjuster knob is removed, the wick life extender control can be seen to contain 3 sequential holes marked ①, ② and ③. By pulling out and turning the control dial counterclockwise, the stem pin of the adjuster can be moved from ① to ② and to ③ position as required. Each step upward from a lower to a higher number increases the maximum wick adjustment range by 2 mm (approx. 1/13 in.).

After the wick life extender's dial has been set, be sure the MANUAL SHUTOFF knob is in the "OFF" position. Replace the wick adjuster knob, making sure it is engaged securely on the wick adjuster shaft.

Repeat steps 1 through 3, as needed, in the section titled "ADJUSTING THE FLAME". When suitable flame length can no longer be achieved even on pin position ③, the wick should be replaced.

NOTE: Do not move adjuster to higher position until lower position no longer gives adequate flame length, even after "burning dry".

Before replacing wick, be sure to move the wick life extender dial back to its ① position.

CHECK THE OPERATION OF THE AUTOMATIC EXTINGUISHER BEFORE LIGHTING YOUR HEATER.

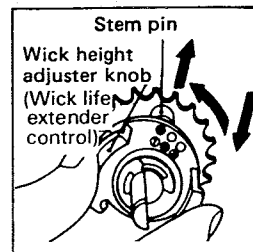

EXTINGUISHING THE FLAME

1. Turn the wick adjuster knob counterclockwise until it stops (about 1/8 turn). Push the button on the wick adjuster knob and continue turning counterclockwise until it stops again (about a half turn). Within a few moments, the flame will be completely extinguished and the heater will be off.
2. Make sure the flame is out completely.
3. Do not try to relight the heater for at least three (3) minutes after turning it off, as this may cause smoke and odor.

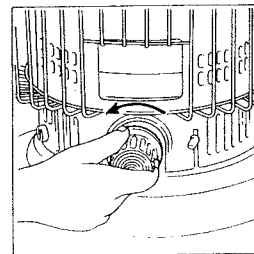

MANUAL SHUTOFF

When quick shutoff is necessary, push down on the manual shutoff.

NOTE: For routine turn-off, DO NOT use the "Manual Shutoff" or activate the "Automatic Extinguisher" by jarring the heater. These methods may cause unwanted odor, soot and smoke. Only the wick adjuster knob should be used for normal shutoff.

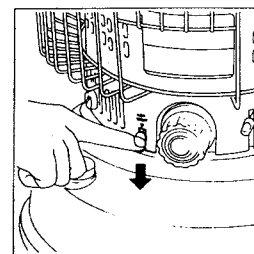

CARE AND MAINTENANCE

As with any good appliance, preventive as well as corrective maintenance is occasionally required. Please read the following section carefully in order to enjoy the greatest benefits from your heater.

WICK INSPECTION AND CLEANING (ONCE A WEEK)

NOTE: One of the simplest but also the most important components of your heater is the wick.

With proper attention, the wick will last at least one heating season and, depending on the quality of the fuel used, possibly longer. It helps to perform routine maintenance operations on the wick.

1. Indications that the wick may need attention are:

- low flame
- tar deposit on the top edge of the wick
- difficulty in turning the wick adjuster knob
- a flickering or dying flame

2. Clean the wick by burning dry as follows:

- 1) When the fuel gauge indicates empty, but the heater is still burning, raise the wick to its highest position and allow the flame to consume the remaining fuel in the tank.

NOTE: Burning the wick dry can at times create odors. For the burning dry procedure, remove your heater from the living area of your house into a well-ventilated area such as a garage or even a sheltered area outside. If you burn the wick dry outside, be sure that the heater is not exposed to strong drafts during the procedure.

- 2) After the heater has cooled completely, remove the heater cover as described in items 1 and 2 of the next section.

- 3) Remove any residue from the wick with a small brush such as an old toothbrush. Cinders or soot in the burner around the wick may be vacuumed away. Be careful when removing such material from the wick with a brush, to do so gently so as not to tear the top surface of the wick.

- 4) Remove any tar deposits on the top of wick adjuster and primary air tube using a scraper.

NOTE: When good wick performance is no longer achieved by the burning dry process, it may be necessary to replace the burned wick with a new one.

- 5) Before reassembling the heater, take a few minutes to wipe the parts with a soft cotton cloth or paper towels.

- 6) Reassemble the heater, following directions in item 11 of the next section.

NOTE: If the flame is still low after cleaning the wick, the wick may contain some water. It is then necessary to replace the wick and empty all kerosene from the fuel tank. Dry the tank thoroughly and refill with fresh, pure No. 1-K kerosene.

INSPECTION OF THE IGNITER COIL (EVERY TIME)

If the wick does not ignite or is hard to ignite, check if the igniter filament is broken.

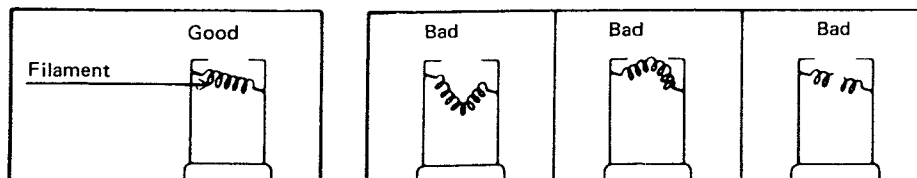

If the igniter coil is found to be defective, replace as described on page 14.

CHECKING THE HEATER

▲ WARNING: Before cleaning your heater, allow it to cool completely.

1. Check for kerosene leaks (REGULARLY)
Make it a habit to check for any sign of kerosene leakage at the fuel tank and the drip tray. Kerosene leaks may lead to risk of fire.
2. Cleaning the outer cover and the fuel tank. (ONCE A WEEK)
Wipe the surface of the outer cover and the fuel tank with a soft cloth.
Stains can be removed with a cloth and a mild soapy solution.
Do not use scouring pads, or harsh abrasives.
3. Heat chamber (ONCE A WEEK)
Loose cinders or soot on the heat chamber can be brushed away.

CHECKING THE AUTOMATIC EXTINGUISHER (ONCE A WEEK)

Test the operation of the automatic extinguisher weekly. A good time to check is before lighting the heater.

1. Turn the wick adjuster knob clockwise until it stops (the same way as to light the heater).
2. Push the manual shutoff and make sure the wick has dropped.
3. Repeat step 1 and then shake the heater and make sure the automatic extinguisher worked.

REPLACEMENT OF PARTS

REPLACING THE WICK

USE ONLY GENUINE TOYOSET REPLACEMENT WICK PART #22741513. SUBSTITUTE WICKS CAN SEVERELY REDUCE PERFORMANCE AND SAFETY, AND WILL INVALIDATE WARRANTY. (See warranty statement on back cover.)

▲ WARNING: Before disassembling your heater, allow it to cool completely.

1. Release the automatic extinguisher by pushing down on the manual shutoff.

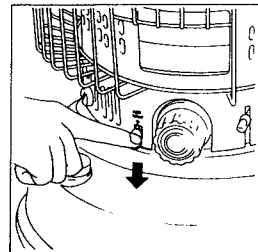

2. Remove the three (3) thumbscrews holding the outer cover, and lift cover off.
Remove batteries from the battery holder.

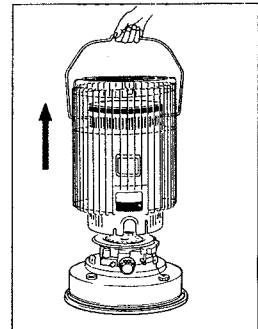
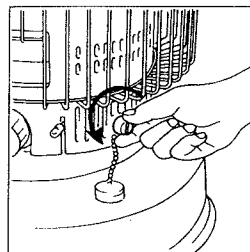

3. Remove the four (4) wing nuts around the wick adjuster. Lift the wick adjuster off the heater while moving it slightly back and forth.

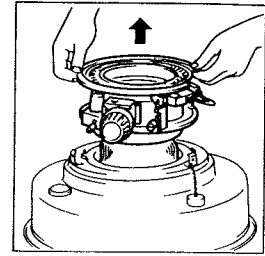

4. Slide two fingers between the wick and the silver wick sleeve attached to the wick adjuster. Lift the pins in the wick off the slots in the wick sleeve. After lifting all three (3) pins off the slots, fold the wick and remove it. Replace the wick sleeve back into the wick adjuster to protect the sleeve from damage.

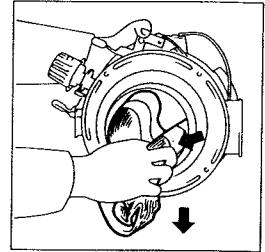

5. Place the wick adjuster on its side. Next, line up the three (3) openings in the wick adjuster: 1) the holes in the sleeve, 2) the diagonal slots in the fixed part of the wick adjuster, and 3) the slots in the moving part of the wick adjuster controlled by the wick adjuster knob.

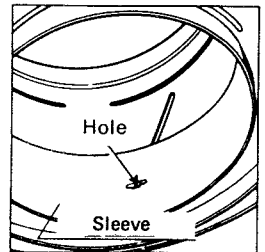

6. Fold the new wick in quarters and insert it into the wick adjuster from wick adjuster bottom. Place one of the pins in one of the lined-up openings. If you experience difficulty, gently turn the wick adjuster knob clockwise. Then insert the two other pins, turning the wick adjuster knob if necessary. Do not bend the sleeve.

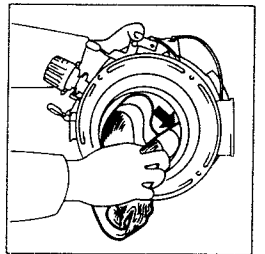

7. Finally, gently press the wick, all along its circumference, against the adjuster to insure that it is firmly in place.

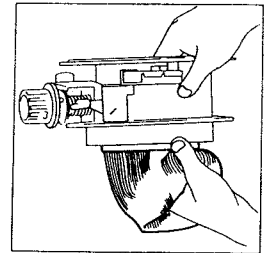

8. Lower the wick adjuster into the fuel tank, guiding the tail of the wick so it fits over the primary air tube and evenly into place.

Point the wick adjuster knob to the front of the heater. Insure that the wick adjuster is centered over the studs on the fuel tank.

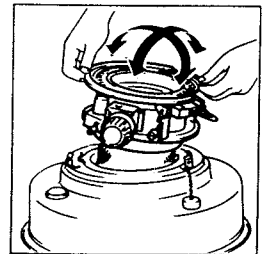

NOTE: The space between the wick adjuster and the primary air tube should be even all around.

NOTE: Make certain the top of the wick adjuster and the top of primary air tube are the same height. If they are uneven, the flames tend to be uneven, too.

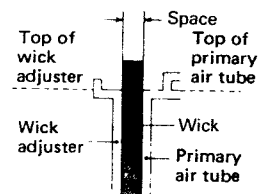

Wick Adjuster
(Cutaway view)

9. Tighten the four (4) wing nuts around the wick adjuster.

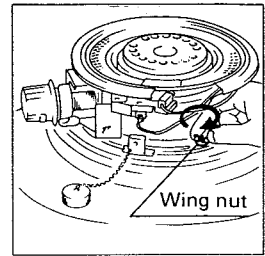

10. Turn the wick adjuster knob to be sure the wick moves smoothly up and down.

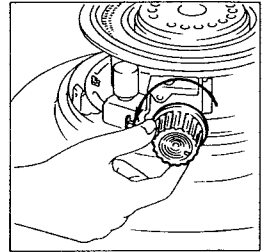

AFTER REPLACING THE WICK, CHECK THE OPERATION OF THE AUTOMATIC EXTINGUISHER BY TURNING THE WICK ADJUSTER KNOB TO ITS FULL ON POSITION AND THEN PUSHING THE MANUAL SHUTUOFF.

Wick height on position ① of the wick life extender should be 8 mm (5/16 in.) when wick adjuster knob is turned fully clockwise. Be sure to check.

NOTE: Remember always to start a new wick on position ① of the wick life extender.

NOTE: If wick does not move smoothly and easily, or wick height on position ① of the wick life extender is not in the range of 7-8 mm (9/32-5/16 in.), do not use heater. Disassemble and repeat items 5 through 10.

NOTE: If any ragged edges appear on the top of the wick, trim them with a scissors carefully. DO NOT cut the body of the wick.

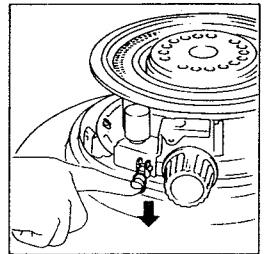

Wick Adjuster (Cutaway view)

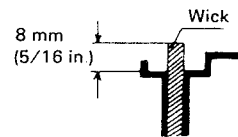

11. Replace the outer cover on the fuel tank and secure it into position with three (3) thumbscrews. Replace batteries in the battery holder.

12. Once again, check the proper operation of the automatic extinguisher.

NOTE: Before lighting a new wick for the first time, turn the wick to its lowest position and allow the wick to saturate with kerosene for about thirty (30) minutes.

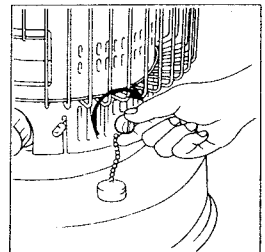

REPLACING THE IGNITER COIL

USE ONLY GENUINE TOYASET REPLACEMENT IGNITER COIL PART #20451618. SUBSTITUTE IGNITER COILS CAN SEVERELY REDUCE PERFORMANCE AND SAFETY.

▲ WARNING: Before replacing the igniter coil, allow the heater to cool completely.

1. REPLACE BATTERIES

When the igniter coil no longer glows sufficiently to light the wick, replace the batteries. If proper glow is not restored, the igniter coil may be defective.

2. CHANGE IGNITER COIL

a) Remove the batteries from the battery holder.

b) Disassemble the heater as described in items 1 and 2 of the preceding section.

- c) To remove the igniter coil, push it in and twist in either direction while holding the sides of the socket with your other hand.
- d) Install the new igniter coil by pressing it into the socket and turning.
- e) Reassemble the heater as described in item 11 of the preceding section.

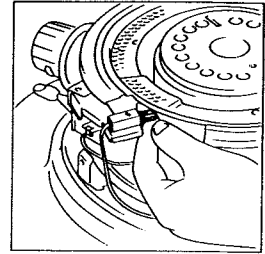

REPLACING THE MICA WINDOW

⚠ WARNING: Before replacing the mica window, allow heater to cool completely.

1. Remove screw from the mica window frame and lift mica window off.
2. Align notch in mica window with hole on mica window frame.
Insert tab of the mica window frame into outer cover slot. Replace screw.

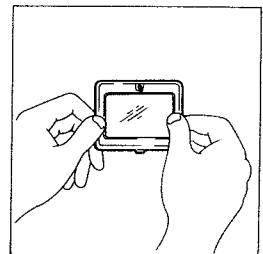
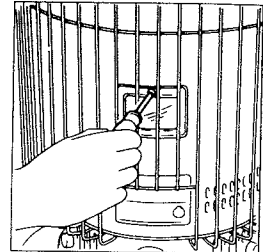

STORAGE

At the end of each heating season, or when you do not plan to use your heater for an extended period of time, the following procedures are recommended:

1. CLEAN WICK AND HEATER

Follow directions in item 2 under "WICK INSPECTION AND CLEANING".

2. DRAIN FUEL TANK

After you have burned your heater dry, a small amount of kerosene will remain in the fuel tank. It should be removed in order to avoid contamination when the heater is refueled at a later date. To do this, remove the fuel cap, tip the heater toward you and insert a small siphon into the bottom-most portion of the fuel tank. Empty the tank completely before storing.

3. REMOVE BATTERIES FROM BATTERY HOLDER

4. STORE HEATER

The original shipping carton is the best place to store your heater. If you do not have original packing materials, cover the heater with a large plastic bag and store in a dry place.

TROUBLESHOOTING

PROBLEM	CAUSE	SOLUTION	PAGE
Wick fails to ignite	Out of fuel	Check fuel gauge; add fuel if necessary.	7
	Igniter coil does not glow	Check wire connections. Replace batteries. Replace igniter coil, if necessary.	6 11, 14
	Water in kerosene/poor quality kerosene	Drain tank. Install new wick. Refill with fresh, clean No. 1-K kerosene.	12
Smoke or odor	Heat chamber tilted or improperly seated	Move wire handle until heat chamber is properly seated and moves smoothly left and right.	8
	Wick set too high	Reduce wick height by turning wick adjuster knob counterclockwise. Check position of the wick life extender.	9
	Dirty wick	Clean wick as described under "Care and Maintenance".	11
	Drafts	Relocate heater.	2
	Contaminated fuel/poor quality kerosene	Drain tank and rinse with clean kerosene. Install new wick and refill with fresh, clean No. 1-K kerosene.	11 12
Flickering, dying or low flame	Dirty wick	Clean wick as described under "Care and Maintenance". If necessary, install new wick.	11 12
	Water in kerosene/poor quality kerosene	Drain tank and rinse with clean kerosene. Install new wick and refill with fresh, clean No. 1-K kerosene.	11 12
	Wick too low to sustain good flame	Raise the wick life extender to step ② or ③. If already at step ③, replace wick.	9 12
Wick adjuster knob is hard to turn	Dirty wick	Clean wick as described under "Care and Maintenance".	11
	Poor quality kerosene	Drain tank and rinse with clean kerosene. Install new wick and refill with fresh, clean No. 1-K kerosene.	11 12
	Damaged mechanism	Contact your dealer for service.	
Flame too high	Fuel contaminated with gasoline or other highly flammable material	IMMEDIATELY shut off heater. Inspect all components for damage. Drain tank and rinse with clean kerosene. Install new wick and refill tank with fresh, clean No. 1-K kerosene.	3 11 12
	Wick set too high	Check position of the wick life extender.	9

LIMITED WARRANTY

TOYOTOMI U.S.A., INC. ("TOYOTOMI") warrants each product and any parts thereof sold by it to be free from defects in materials or workmanship under normal use and service for TWELVE (12) MONTHS from the date of delivery to the original purchaser at retail subject to the following terms and conditions:

WHAT IS COVERED: Product or any parts thereof which are defective in materials or workmanship

WHAT IS NOT COVERED:

(1) This warranty does not extend to any defect due to the negligence of others; failure to install, operate or maintain unit in accordance with installation instructions (operating and maintenance instructions are furnished with each new unit); unreasonable use; accidents; alteration; use of unauthorized or non-standardized Toyotomi parts and accessories; electrical malfunction, i.e., as resulting from power surges, short circuit, etc.; incorrect installation; use of any fuel other than that specified in owners manuals; or repair by anyone other than a service facility specified by Toyotomi.

(2) Normal wear and tear of parts including wicks, batteries, igniter coils and siphons, cutting blades, hoses, cables, burner mats and accessories

(3) This warranty does not cover shipping costs

WHO IS COVERED: The original purchaser at retail

WHAT WE WILL DO: TOYOTOMI will either repair or replace, at its option, all defective parts free of charge that are covered by this limited warranty on a carry-in basis, to your nearest authorized dealer or distributor of TOYOTOMI

WHAT YOU MUST DO FOR WARRANTY SERVICE: You must return the defective Product or part to any authorized dealer or distributor of TOYOTOMI with this LIMITED WARRANTY and a copy of your bill of sale or credit card charge receipt or other document evidencing the date of the Product's delivery. If service is not available locally, please contact our CUSTOMER RELATIONS DEPARTMENT at:

TOYOTOMI U.S.A., INC.
604 Federal Road, Brookfield, CT 06804
(203) 775-1909

THE FOREGOING EXPRESSES ALL OF TOYOTOMI'S OBLIGATIONS AND LIABILITIES WITH RESPECT TO THE QUALITY OF PRODUCT FURNISHED BY IT. ALL OTHER WARRANTIES, EXPRESS OR IMPLIED, INCLUDING THE WARRANTIES OF MERCHANTABILITY OR FITNESS FOR A PARTICULAR PURPOSE ARE DISCLAIMED. TOYOTOMI SHALL NOT BE LIABLE FOR THE LOSS OF USE OF THE PRODUCT, INCONVENIENCE, LOSS OR ANY OTHER DAMAGES, DIRECT OR CONSEQUENTIAL ARISING OUT OF THE USE OF, OR INABILITY TO USE THE PRODUCT OR DAMAGES RESULTING FROM OR ATTRIBUTABLE TO DEFECTS IN THE PRODUCT.

No one other than TOYOTOMI has authority to extend or modify the terms of this Limited Warranty in any manner whatsoever.

Some states do not allow the exclusion or limitation of incidental or consequential damages or limitations on how long an implied warranty lasts, so these limitations or exclusions may not apply to you. This Limited Warranty gives you specific legal rights and you may also have other rights which vary from state to state.

NOTE: An extended warranty period of 36 months is offered for vented heaters only. This coverage is limited to the combustion assembly, specifically the burner pot, radiant chamber and heat exchanger. The remainder of vented heater is subject to 12 months.

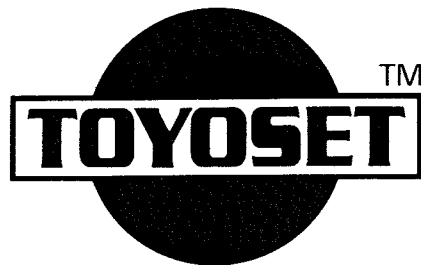

TOYOTOMI

TOYOTOMI U.S.A., INC.
P.O. Box 176, Brookfield, CT 06804-0176

This manual supersedes earlier editions. PART No. 20457794